

Installation Manual

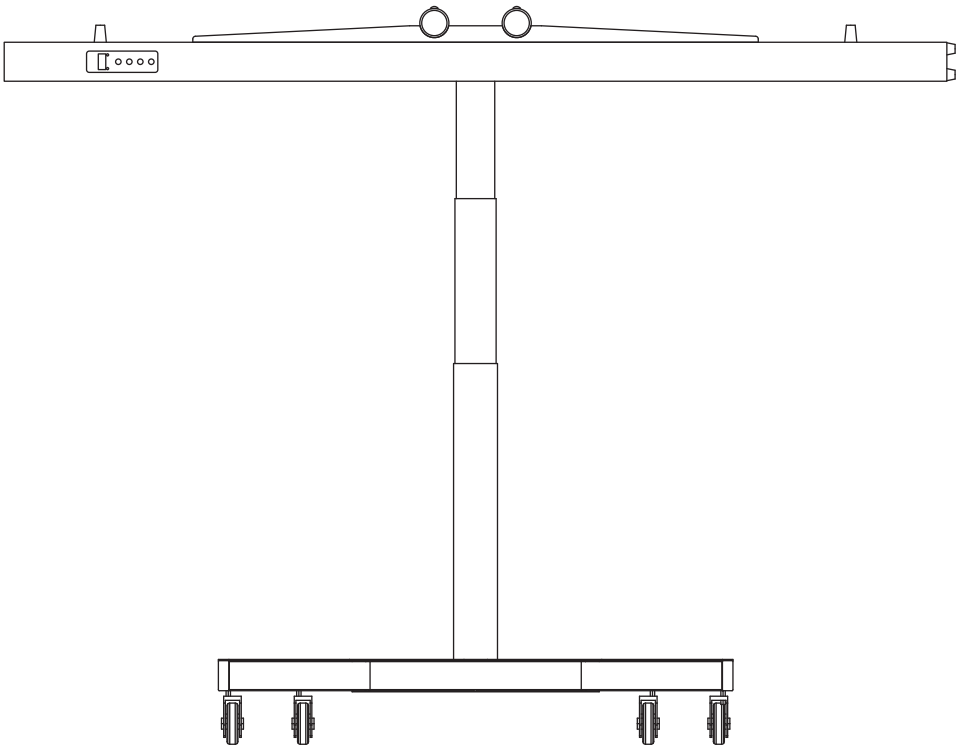

Component Parts

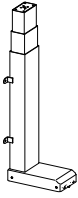

A) Square Post
(1)



B) Base
(1)



C) Universal Wheel
(4)

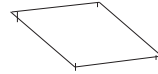

D) Base Plate
(1)



E) Remote Control
(1)



F) Power Cord
(1)



G) Adaptor
(1)

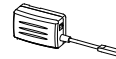

H) Control Box
(1)

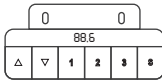

I) Wire Controller
(1)



J) Fixing Rod For Lamp
(2)



K) Transverse Brace
(2)

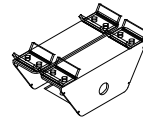

L) Lifting Rod Connection
(1)

Screws List



M) Screws
M6*14(20)



N) Screws
M8*60(8)



O) 4mm Hexagon Wrench
(1)



P) 5mm Hexagon Wrench
(1)



Q) Cross Screws
M5*10(6)



R) Screws
M8*20(4)



S) Screws
M6*16(6)

1. Put the control system into the corresponding position according the picture, except the wire controller.

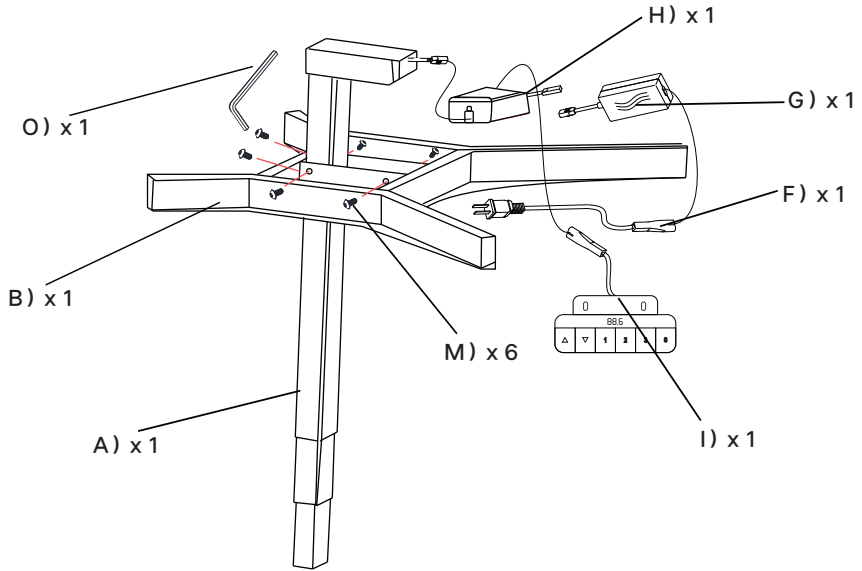

2. Fix cross screw M5*10 by cross screwdriver as picture.

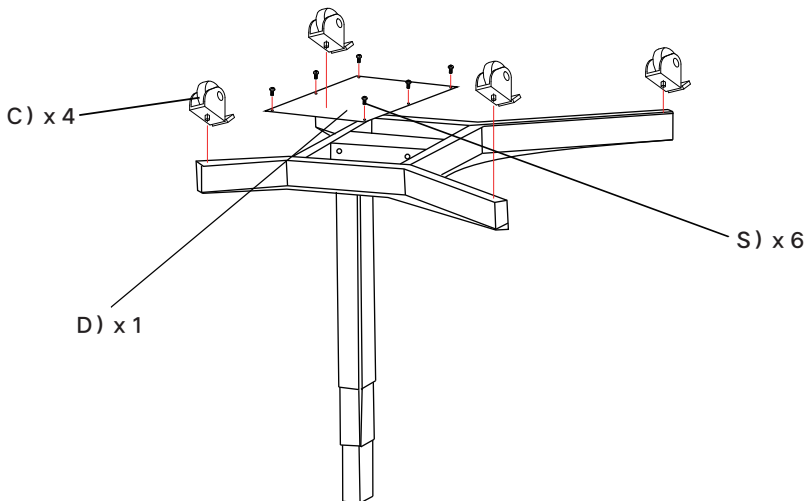

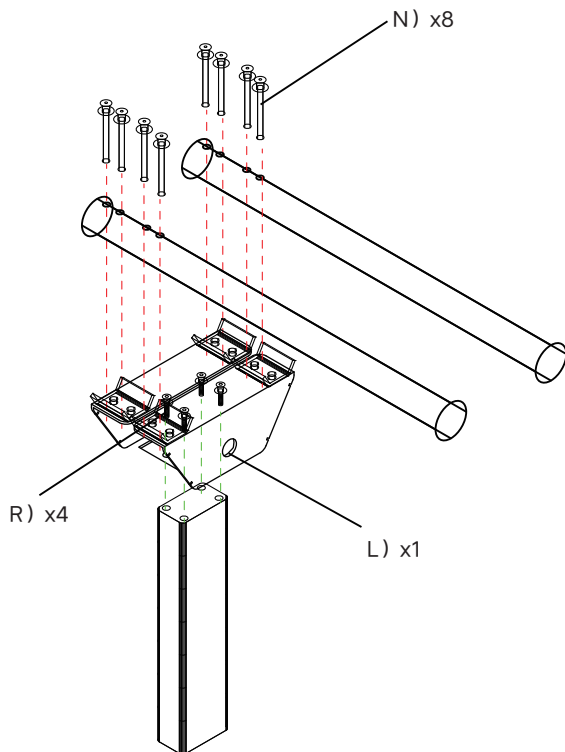

Operation Manual

Remote Control

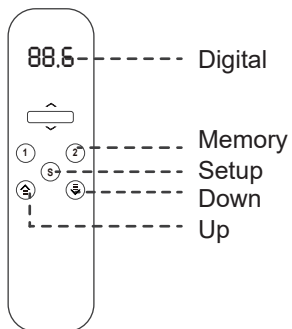

Controller

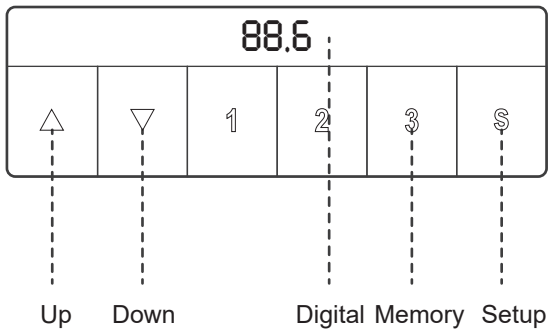

Remote control matching

Keep press the up button“ ^ ”, also connect both adapt and controller box meanwhile, until we hear the buzzing.

Reset Operation

After successful connection between control system and Lift Column,please hold the Down Button" ∨ "for several seconds,the system enters initialization mode.Then remove handset until handset of LED display shows number(height).

Column Stop Operation

Remote Control:When the column during rising, you want to stop it,then you can press the button" o ",the column will stop to rise.And if necessary to stop the column during the descent,you can press the button"o",it will stop to go down.

Memory function

Handset:Touch "S" button,indicator show "S-",meanwhile "S-" flicker,at the same time touch "1-4" button to reserve this position to relative "1-4",four memory positions can reserve.

Unit Conversion

Keep press"S" for 8s,the unit "cm""inch"system will switch automatically.

Operation System Protection

After runs continuously for 3~4 times,control system will be in protection position. The handset shows "HOT",meanwhile,the remote control and handset will be invalid. 18mins later,automatically connect or directly power off.(power off refers to indicator light of adapter goes out)

Precautions:

- 1) The product shall be used in accordance with the technical parameters;
- 2) Keep away from corrosive gas and dusty environment,pay attention to waterproof.

It can work normally after doing RESET operation when controller show “RST”.

panel mounted on stand

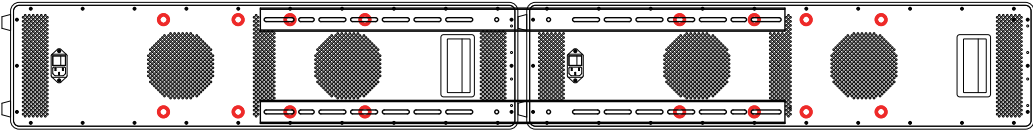
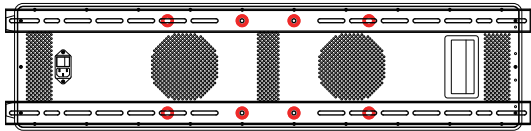
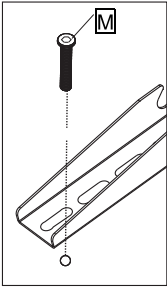

RH1000

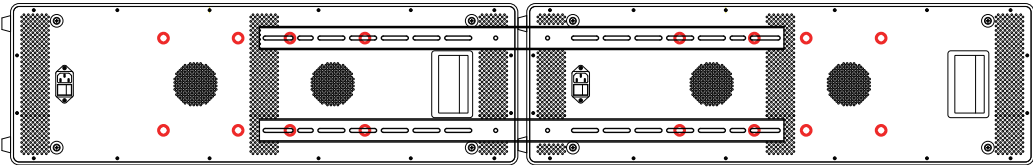
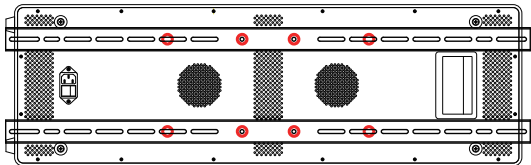

RH1500

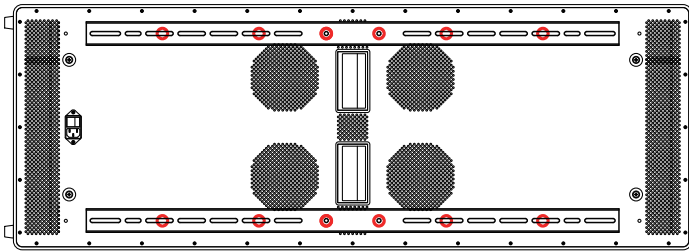
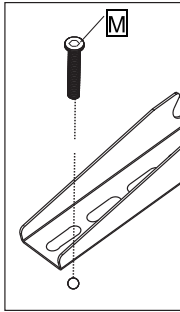

RH2400

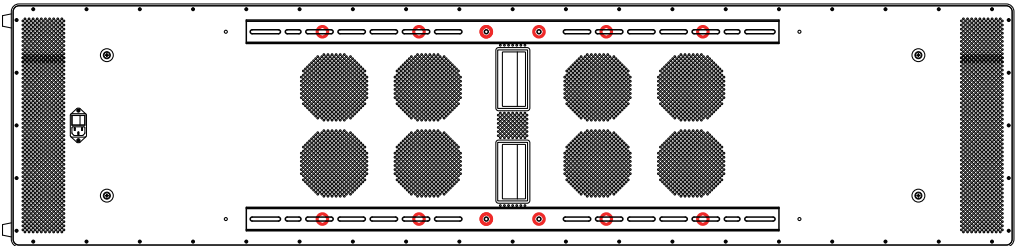

Full Body

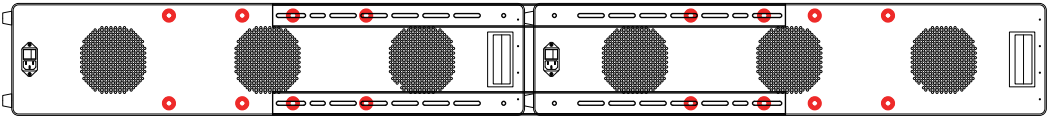
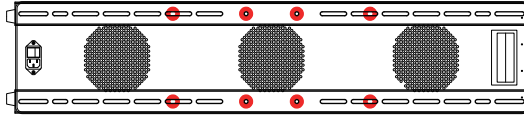
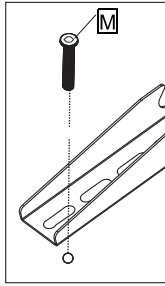

AL1000

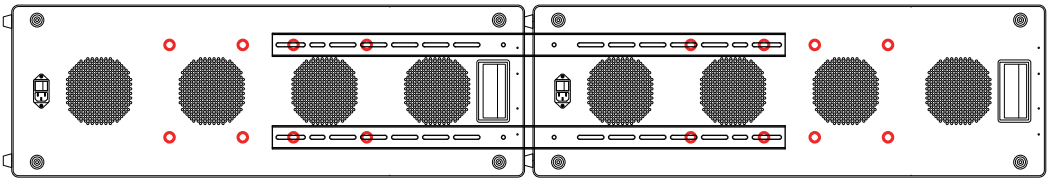
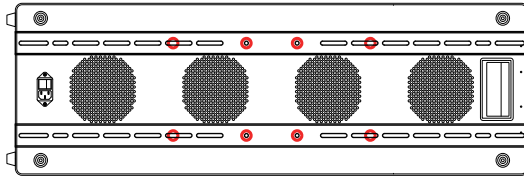

AL1500

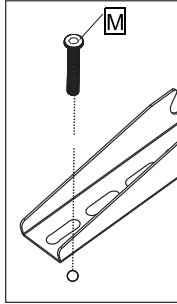

J) x 2

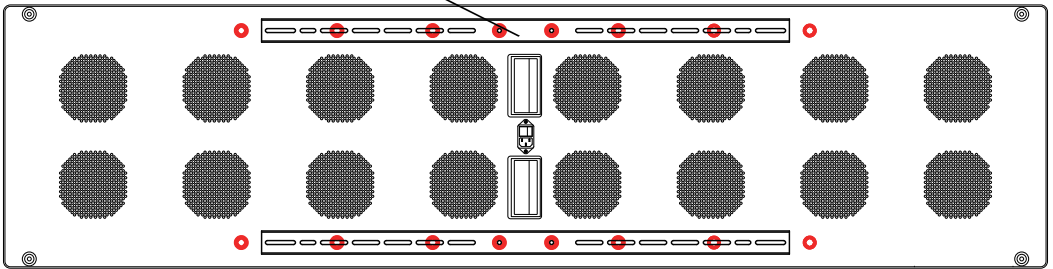

AL6000

panel mounted on stand

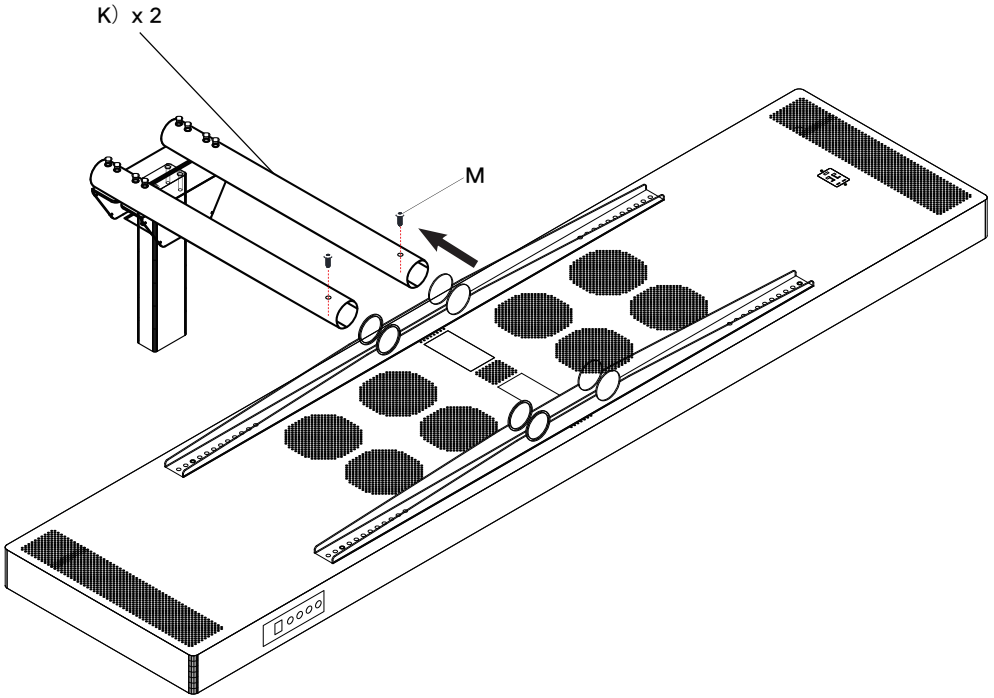

The light panel can be rotated 90° and use for vertical and horizontal use.

